



COSMOPOLITAN
HOTELS GROUP



GRAND HOTEL
CONTINENTAL

MEETING ROOMS

The rooms are modern, all lit by natural light, with the possibility of darkening and equipped with air conditioning and heating. Each of them has characteristics and dimensions among which you can choose according to your needs and the nature of the event.

AUDIO VISUAL EQUIPMENT

- **GIANT SCREEN**
- **VIDEO PROJECTOR**
- **DIRECT CAB**
- **WI-FI**
- **WELCOME AREA FOR REGISTRATION OF PARTICIPANTS**
- **PODIUM WITH MICROPHONE**
- **FLIP CHART**
- **LAPTOPS**
- **DVD PLAYER**



MEETING ROOM

FERRETTI ROOM

DIMENSION: m² 416

DIMENSION: mt 33.50x12.50

MIN HEIGHT: mt 2.50

MAX HEIGHT: mt 3.10

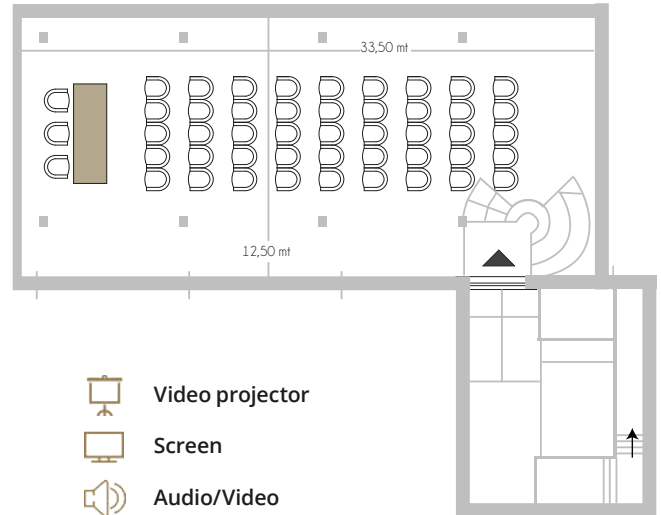





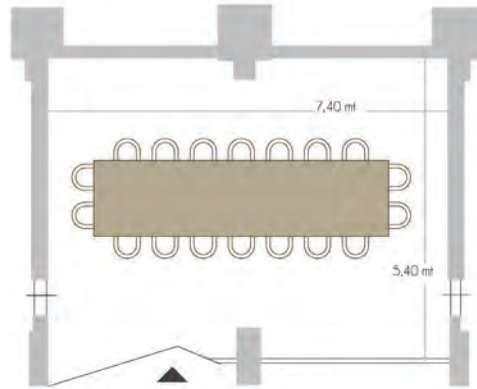

MEETING ROOM

DOMENICI ROOM

DIMENSION: m² 40
DIMENSION: mt 7.40x5.40
MIN HEIGHT: mt 2.50
MAX HEIGHT: mt 3.10

CAPACITY 20



-  Video projector
-  Screen
-  Audio/Video
-  Wi-Fi
-  Microphones
-  Coffee break



MEETING ROOM

FATTORI ROOM

DIMENSION: m² 85
DIMENSION: mt 15x4.70
HEIGHT: mt 2.60

CAPACITY 60

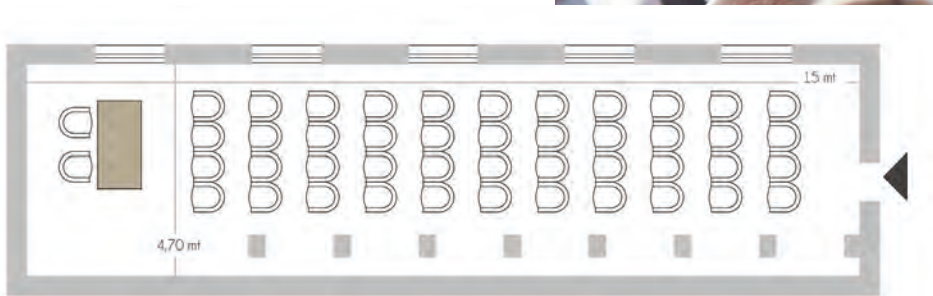

- Video projector
- Screen
- Audio/Video
- Wi-Fi
- Microphones
- Coffee break

BELVEDERE ROOM

DIMENSION: m² 150
DIMENSION: mt 13.40x11.50
HEIGHT: mt 2.70

CAPACITY 80



- Video projector
- Screen
- Audio/Video
- Wi-Fi
- Microphones
- Coffee break

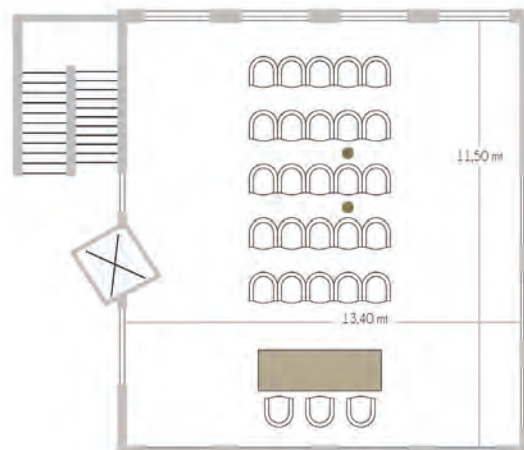

MEETING ROOM

SIMONELLI ROOM

DIMENSION: m² 90
DIMENSION: mt 12x7.60
HEIGHT: mt 3.50

CAPACITY 80

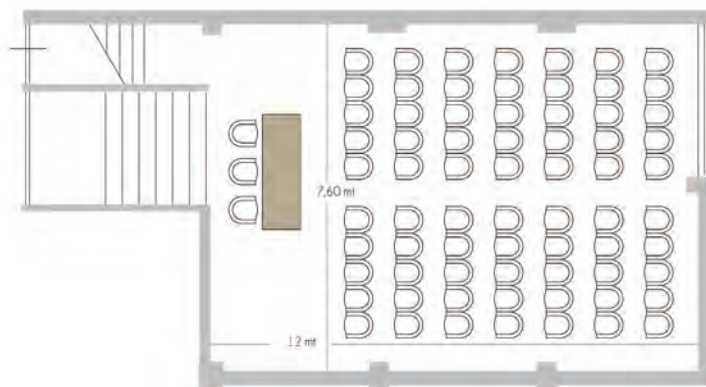

-  Video projector
-  Screen
-  Audio/Video
-  Wi-Fi
-  Microphones
-  Coffee break



"SALONE BRUSCHI"

The Salone Bruschi is a spacious, luminous hall which particularly suited for hosting exhibitions or fashion shows. The hall boasts modern furniture and a warm, intimate atmosphere, making it ideal for hosting events in style. The Salone Bruschi offers air conditioning and central heating, depending on the time of year.

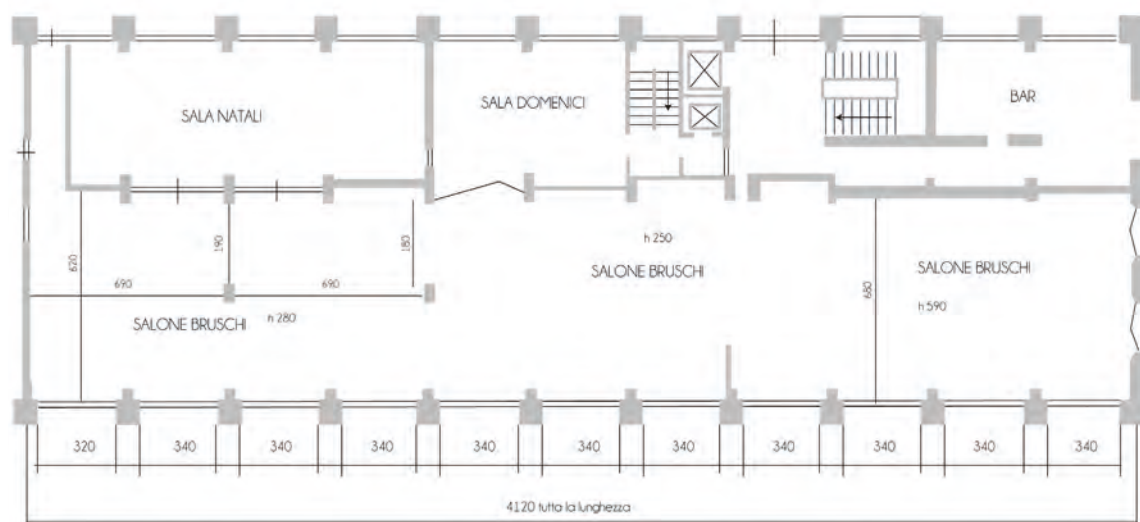

DIMENSION: m² 320
MIN HEIGHT: mt 2.60
MAX HEIGHT: mt 5.60



TEAM BUILDING



18-HOLE GOLF COURSE - TIRRENIA

The 18 holes of the Cosmopolitan Golf & Country Club, par 72, twist and turn through a surface of 70 hectares, in an area modeled in the most rigorous respect for nature, in which wind, sand and water combine to make it technically interesting.

GUIDED TOURS - SAN ROSSORE PARK, MASSACIUCCOLI, MIGLIARINO

The itineraries, of the guided tours performed by the regional park authority, are mainly developed on flat lands, a characteristic that makes them easily walkable even without special training. It is allowed to ride a bike or a horse-drawn carriage.

PARAGLIDING FLIGHT - TWO SEATER TO S.GIULIANO TERME

Tandem flights are mainly carried out on the Pisan mountain range (maximum height 917 meters), taking off from San Giuliano Terme and climbing up again through the thermal currents.

TEAM BUILDING

PECCIOLI ADVENTURE - PISA

Peccioli Adventure Park is a unique artificial structure, because it is located in the Caffè Haus garden in the historic center, in front of the splendid scenery of the Valdera hills.

TREKKING CAI-ROUTES

We are pleased to list some easy itineraries in the open air, at a short distance from the Hotel, in the Pisan hills where you can be in contact with nature, suitable for everyone, even for inactive persons with a duration which varies from 1 to 3 hours. The itineraries are the following:

- Passo di Dante, S. Giuliano Terme
- Mirteto through the Valle delle Fonti in Asciano
- Spuntone di Santallago a 2 hour walk in Calci
- Salita di Castellare, S. Giuliano Terme.

A FLIGHT IN HOT AIR BALLOON - LUCCA

Flying over the hills and vineyards of Tuscany with One-hour flight. To experience the magic of the balloon, driven only by the wind and the heat of the flame, you will reach an altitude of about 6,000 meters and will be carried away by the wind.

PAINTBALL - COLTANO

A short distance from Tirrenia the paintball field represents an exciting, fun and effective opportunity, which takes place in specific equipped camps where players - equipped with compressed air markers - find themselves hitting and to be hit by opponents with brightly colored paint balls.

POLIGONO DI TIRO - LIVORNO

CITY BIKE RENTAL, MOUNTAIN BIKE AND E-BIKE

A bike rental which hires mountain bikes, city bikes and E-bikes for rides on the Pisan coast

FOOD EXPERIENCE

For an excellent Food experience, the Truffle Experience around San Miniato allows you to go to the discovery of the White Truffle, one of the finest.

Truffle hunting with strolls in the woods, guided by truffle collectors and truffle dogs.



GRAND HOTEL
CONTINENTAL
TIRRENIA-PISA

Largo Belvedere, 26 56128 Tirrenia (PI)
T. +39 050 37031 - info@grandhotelcontinental.it
grandhotelcontinental.it



COSMOPOLITAN
HOTELS GROUP

CHGROUP.EU